

770-743

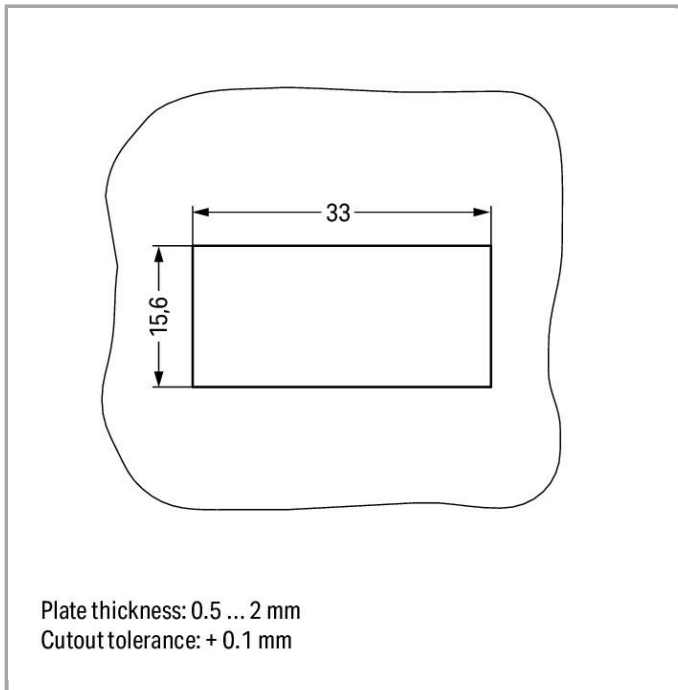
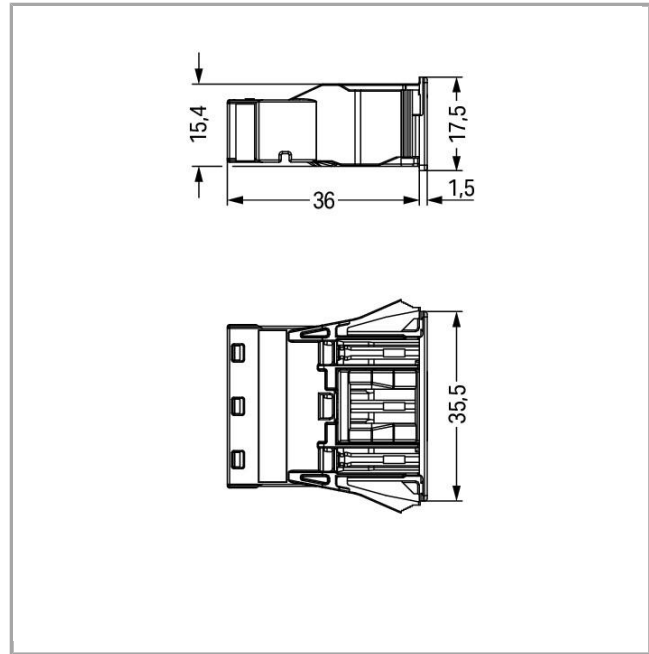
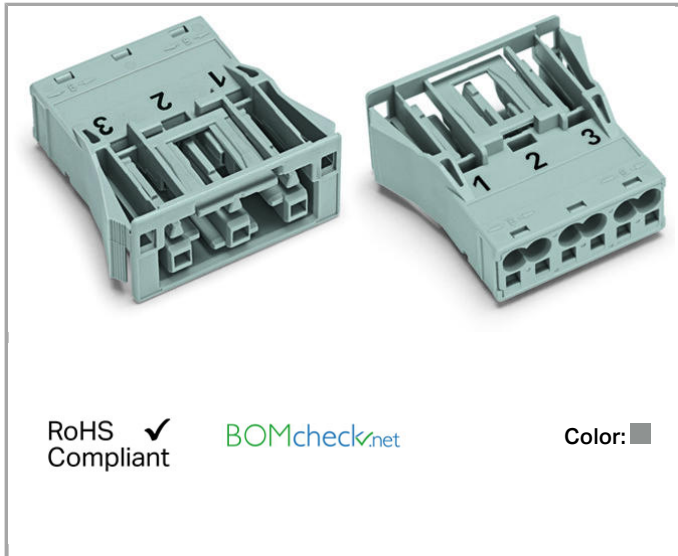

### Item description

- Protected against mismatching and maintenance-free

—



- Push-in CAGE CLAMP® spring pressure connection technology allows solid conductors to be simply pushed into a unit
- Two-wire connection per pole for loops or bridges
- Additional variable coding is possible
- Components can be clearly printed on and color-coded to meet custom requirements

**Note:**

All connectors for mounted installations (snap-in versions for lighting fixtures or devices, all types of PCB and distribution connectors) are factory-equipped with locking levers to ensure plugs and sockets are securely locked. Additional locking levers are only required for flying leads (plug /socket).

**Safety information 1:**

Application note for the U.S. market (USR): Some versions may also be used for current interruption in accordance with the UL certificate in select applications with currents below 16 A and voltages up to 600 V. For further information, please contact your local sales office.

**Data****Electrical data**

Note on Contact Resistance

approx. 1mΩ contact resistance

approx. 0.25mΩ contact transition plug/socket

**Ratings per IEC/EN 60664-1**

Rated voltage (III / 3)	250 V
Rated impulse voltage (III / 3)	4 kV
Rated current	25 A

**Approvals per UL 1977**

Rated voltage per UL 1977 (factory wiring only)	600 V
Rated current per UL 1977 (factory wiring only)	23 A

**Connection data**

Connection technology	Push-in CAGE CLAMP®
Actuation type	Operating tool Push-in
Nominal cross section	4 mm <sup>2</sup>
Solid conductor	0.5 ... 4 mm <sup>2</sup> / 20 ... 12 AWG
Solid conductor, push-in termination	1.5 ... 4 mm <sup>2</sup> / 16 ... 12 AWG
Stranded conductor	0.5 ... 2.5 mm <sup>2</sup> / 20 ... 14 AWG

Fine-stranded conductor	0.5 ... 4 mm <sup>2</sup> / 20 ... 12 AWG
Fine-stranded conductor with ferrule with plastic collar	0.25 ... 1.5 mm <sup>2</sup> / 20 ... 16 AWG
Fine-stranded conductor with ferrule without plastic collar	0.25 ... 2.5 mm <sup>2</sup> / 20 ... 14 AWG
Strip length	9 mm / 0.35 inch
Note (strip length)	see also packaging or instructions
No. of poles	3
Total number of connection points	6
Total number of potentials	3
Conductor entry direction to mating direction	0°

### Geometrical Data

Pin spacing	10 mm / 0.394 inch
Width	35.5 mm / 1.398 inch
Height	17.5 mm / 0.689 inch
Depth	36 mm / 1.417 inch

### Mechanical data

Coding	B
Mating force of a plug-in connection	approx. 20 ... 70 N (depending on pole number)
Retention force of a plug-in connection	When locked: > 80 N
Unmating force of a plug-in connection	when unlocked: approx. 20 ... 70 N (depending on pole number)
Number of mating cycles	200, without resistive load  100, with resistive load $I_N = 25A$ , tested (4 mm <sup>2</sup> /AWG 12)
Gehäuseblechstärke	0.5 ... 2 mm / 0.02 ... 0.079 inch
Mounting type	Snap-in
Marking	1 2 3
Protection class	IP20
Note on protection class	Only in mated condition with strain relief housing (These compact connectors are not designed for use in open, easily accessible areas.)
Potential marking	1 2 3

### Plug connection

Contact type (pluggable connector)	Female connector/socket
Connector connection type	for conductors
Mismating protection	Yes
Locking of plug-in connection	locking lever

Locking lever	yes
---------------	-----

## Material Data

Color	gray
Insulating material	Polyamide 66 (PA 66)
Flammability class per UL94	V0
Clamping spring material	Chrome nickel spring steel (CrNi)
Contact material	Copper or copper alloy, surface-treated
Fire load	0.231 MJ
Weight	11.895 g

## Environmental Requirements

Surrounding air (operating) temperature	-35 ... 85 °C
Processing temperature	-5 ... +40 °C
Continuous operating temperature	-35 ... +85 °C
Note on Continuous Service Temperature	Insulating parts for temperatures ≤ 105 °C

## Commercial data

Country of origin	DE
GTIN	4044918252676
Customs Tariff No.	85366990990

## Approvals / Certificates

### Country specific Approvals

Logo	Approval	Additional Approval Text	Certificate name
	CCA DEKRA Certification B.V.	EN 61984	2173495.01
	CCA DEKRA Certification B.V.	IEC 61984	NL-32104

### Ship Approvals

Logo	Approval	Additional Approval Text	Certificate name
	ABS American Bureau of Shipping	-	14- HG1241528- PDA
	DNV GL Det Norske Veritas, Germanischer Lloyd	-	TAE00001Z6

**DNV GL**

Det Norske Veritas, Germanischer Lloyd

-

TAE00001Z6

**LR**





Lloyds Register

IEC 61984



02/20050  
(E6)**UL-Approvals**

Logo	Approval	Additional Approval Text	Certificate name
	cURus Underwriters Laboratories Inc.	UL 1977	E45171 Sec. 9

**Compatible products****protection**

	<b>Item no.: 770-201</b> Lockout cap; 12-pole, separable; 12-pole; for sockets	770-201
	<b>Item no.: 770-221</b> Lockout cap; for socket; 12-pole; separable	770-221
	<b>Item no.: 770-643</b> Lockout cap; 3-pole; for cutouts; Plastic	770-643
	<b>Item no.: 770-693</b> Lockout cap; for cutout; for cutouts; Plastic	770-693

**tools**

	<b>Item no.: 210-720</b> Operating tool with partially insulated shaft; Type 2, blade (3.5 x 0.5) mm	210-720
	<b>Item no.: 770-383</b> Operating tool; 3-way	770-383

**Downloads****Documentation****Bid Text**

770-743

Apr 4, 2012

doc

Download



WINSTA MIDI 3-polig

23.6 kB

---

### CAD/CAE - Smart Data

#### CAD data

3D Download 770-743

URL

Download

---

Subject to changes.

---